

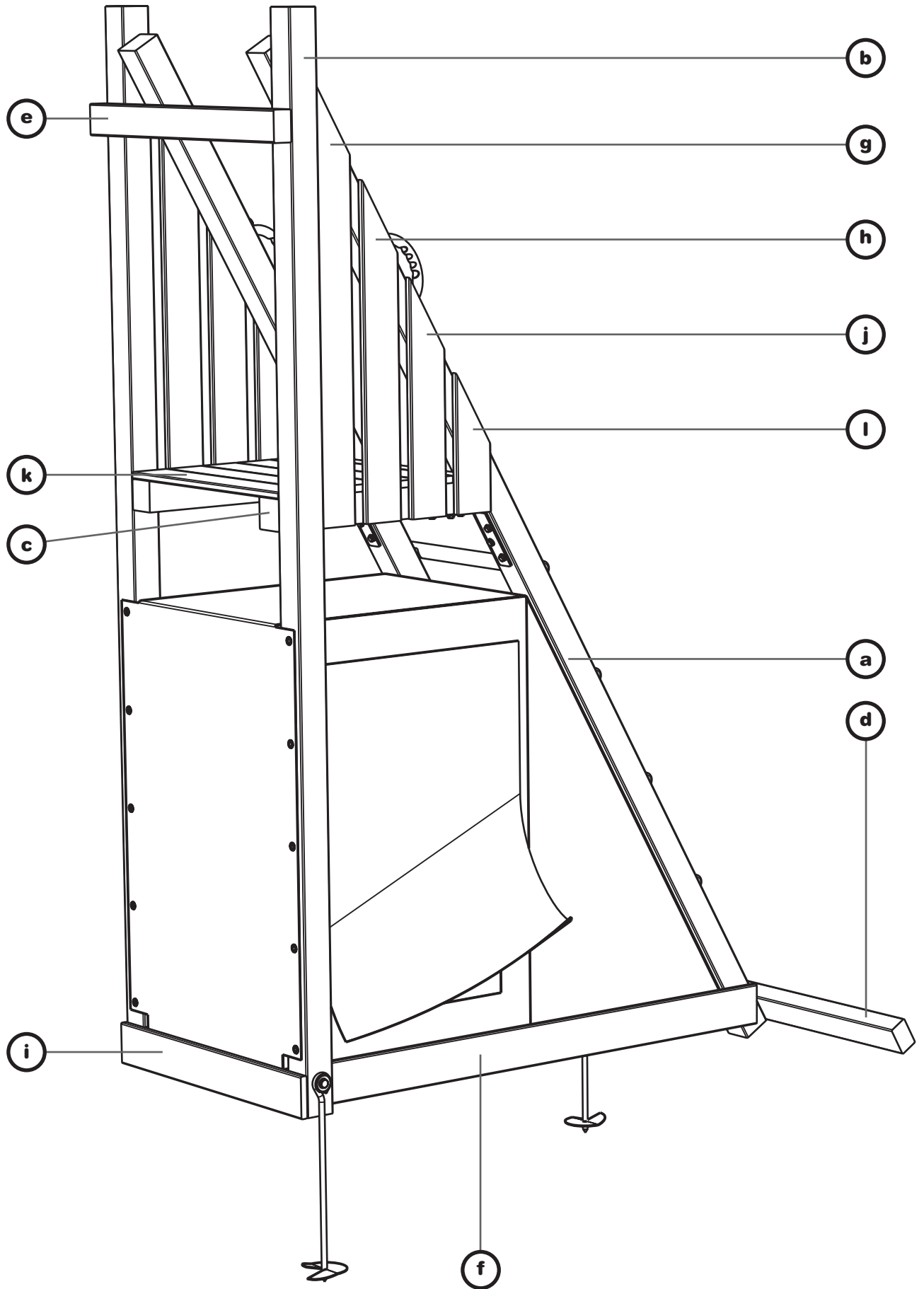











FREESLIDE













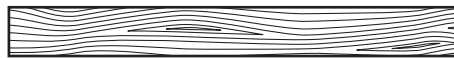



FREESLIDE

- 2x** **a** — min 6,4 cm max 9 cm   270 cm
- 2x** **b** — min 6,4 cm max 9 cm   240 cm
- 2x** **c** — min 6,4 cm max 9 cm   60 cm

- 1x** **d** — min 7 cm max 9 cm   150 cm
- 1x** **e** — min 7 cm max 9 cm   70 cm

- 2x** **f** — min 9 cm max 14 cm   135 cm
- 2x** **g** — min 9 cm max 14 cm   100 cm
- 2x** **h** — min 9 cm max 14 cm   80 cm
- 1x** **i** — min 9 cm max 14 cm   70 cm
- 2x** **j** — min 9 cm max 14 cm   60 cm
- 2/4x** **k** — min 9 cm max 14 cm   56 cm
- 2x** **l** — min 9 cm max 14 cm   40 cm

